

## **AXIS P5635-E Mk II PTZ Dome Network Camera**

## **User Manual**

# AXIS P5635-E Mk II PTZ Dome Network Camera

## Table of Contents

---

<b>Product overview</b> .....	3
<b>How to access the product</b> .....	4
How to access the product from a browser .....	4
About secure passwords .....	4
<b>Setup</b> .....	6
About the product's built-in help .....	6
Image quality .....	6
Streaming and storage .....	8
Overlays .....	9
PTZ (Pan Tilt Zoom) .....	9
Events .....	10
Applications .....	14
<b>Troubleshooting</b> .....	15
How to reset to factory default settings .....	15
How to check the current firmware .....	15
How to upgrade the firmware .....	15
Technical issues, clues and solutions .....	16
Performance considerations .....	17
<b>Specifications</b> .....	18
LED indicators .....	18
SD card slot .....	18
Buttons .....	18
Connectors .....	18
AXIS Multicable C I/O Audio Power .....	19
Axis 10-pin push-pull system connector (sold separately) .....	20

# AXIS P5635-E Mk II PTZ Dome Network Camera

## Product overview

---

### Product overview

**NOTICE**

Make sure the dome is attached in operation mode, otherwise focus may be affected.

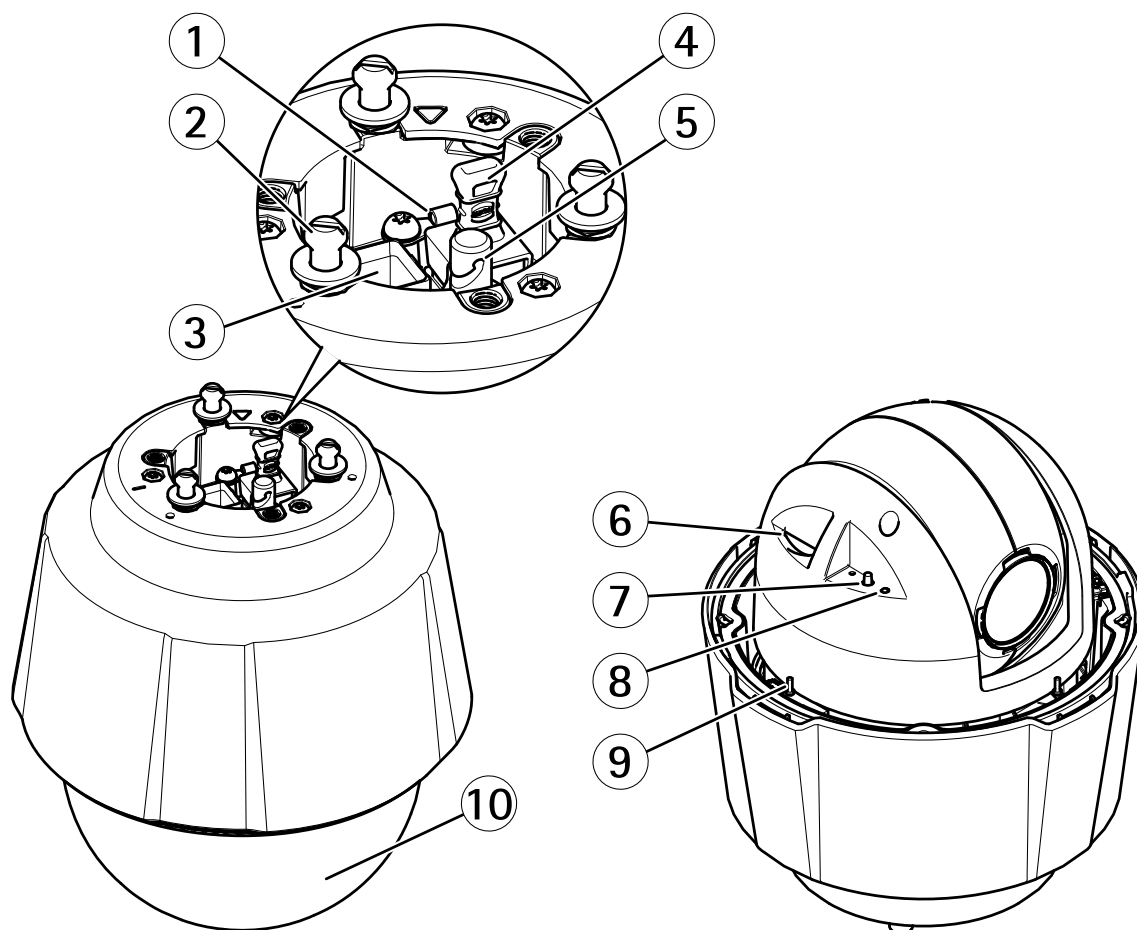

- 1 Ground screw
- 2 Mounting screws (3)
- 3 Network connector (PoE+)
- 4 Multi-connector with cover (Do not remove the cover unless an I/O-cable is connected)
- 5 Hook for safety wire
- 6 SD memory card slot
- 7 Control button
- 8 Status LED indicator
- 9 Power button
- 10 Dome

# AXIS P5635-E Mk II PTZ Dome Network Camera

## How to access the product

---

### How to access the product

AXIS IP Utility and AXIS Camera Management are recommended methods for finding Axis products on the network and assigning them IP addresses in Windows®. Both applications are free and can be downloaded from [axis.com/support](https://axis.com/support)

The product can be used with the following browsers:

- Chrome™ (recommended), Firefox®, Edge®, or Opera® with Windows®
- Chrome™ (recommended) or Safari® with OS X®
- Chrome™ or Firefox® with other operating systems.

### How to access the product from a browser

1. Start a web browser.
2. Enter the IP address or host name of the Axis product in the browser's address field.

To access the product from a Mac computer (OS X), go to Safari, click on Bonjour and select the product from the drop-down list.

If you do not know the IP address, use AXIS IP Utility to locate the product on the network. For information about how to discover and assign an IP address, see the document *Assign an IP Address and Access the Video Stream* on Axis Support web at [axis.com/support](https://axis.com/support)

#### Note

To show Bonjour as a browser bookmark, go to **Safari > Preferences**.

3. Enter your username and password. If this is the first time the product is accessed, the root password must first be configured.
4. The product's live view page opens in your browser.

### About secure passwords

#### Important

When setting the initial password, the password is sent in clear text over the network. If there is a risk of network sniffing, first set up a secure and encrypted HTTPS connection before resetting the passwords.

The device password is the primary protection for the data and services. Axis' products do not impose a password policy as products may be used in various types of installations, but to protect your data do the following:

- Don't use the default password that comes with the products.
- Use a password with at least 8 characters, preferably using a password generator.
- Don't expose the password.
- Change password at a recurring interval, at least once a year.

### Set a password for the root account

#### Important

The default administrator user name **root** cannot be deleted. If the password for root is lost, the product must be reset to the factory default settings.

# AXIS P5635-E Mk II PTZ Dome Network Camera

## How to access the product

---

The default root account has full privileges and should be reserved for administrative tasks. Always create a user account with limited privileges for daily use. This reduces the exposure of the administrative account.

1. Make sure to follow the instructions about secure passwords, see *About secure passwords on page 4*.
2. Type a password and then retype it to confirm the spelling.
3. Click **Create login**. The password has now been configured.

# AXIS P5635-E Mk II PTZ Dome Network Camera

## Setup

---

### Setup

#### About the product's built-in help

You can access the built-in help through your product's web page. The help provides more detailed information on the product's features and their settings.

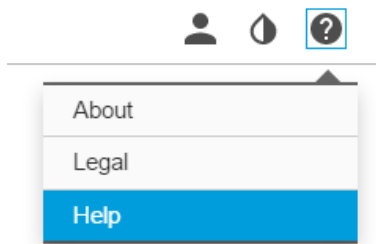

#### Image quality

##### How to focus faster using focus recall areas

To save the focus settings at a specific pan/tilt range, add a focus recall area. Each time the camera moves into that area it recalls the previously saved focus. It's enough to cover half of the focus recall area in the live view.

We recommend the focus recall feature in the following scenarios:

- When there is a lot of manual operation in live view, for example with a joystick.
- Where PTZ preset positions with manual focus are not efficient, for example movements where the focus setting changes continuously.
- In low-light scenarios, where the autofocus is challenged by the lighting conditions.

##### Important

- The focus recall overrides the camera's autofocus at the specific pan/tilt range.
- A preset position overrides the focus setting saved in the focus recall area.
- The maximum amount of focus recall areas is 20.

##### How to add a focus recall area

1. Pan, tilt and zoom into the area where you would like to have focus.
2. Set the focus, either use the autofocus or adjust manually. As long as the focus recall button shows a plus, you can add a

focus recall area in that position. 

3. Click on the focus recall button.

##### How to remove a focus recall area

1. Pan, tilt and zoom into the focus recall area you want to remove. The focus recall button toggles to minus when the

camera detects a focus recall area. 

2. Click on the focus recall button.

# AXIS P5635-E Mk II PTZ Dome Network Camera

## Setup

---

### How to handle scenes with strong backlight

Use WDR to make both dark and bright areas of the image visible.

1. Go to Settings > Image.
2. Turn on WDR under Wide dynamic range.



*Image without WDR.*



*Image with WDR.*

#### Note

If you use WDR, you may experience some WDR artifacts in the image.

Find out more about WDR and how to use it at [axis.com/web-articles/wdr](https://axis.com/web-articles/wdr)

### How to hide parts of the image with privacy masks

If you want to hide parts of the image due to privacy reasons, use one or several privacy masks.

#### What is a privacy mask?

A privacy mask is a user-defined area that prohibits users from viewing parts of the monitored area. Privacy masks appear as blocks of solid color or blurred image elements and are applied on the video stream.

Privacy masks are present on all snapshots, recorded video, and requested streams. They can not be bypassed through the VAPIX® application programming interface (API).

The privacy mask is relative to the pan, tilt, and zoom coordinates which means that regardless of the angle and zoom, the privacy mask covers the same place or object.

#### Important

If you add many privacy masks, this may affect the product's performance.

# AXIS P5635-E Mk II PTZ Dome Network Camera

## Setup

---

How to create a privacy mask

To create or edit a privacy mask, go to **Settings > Privacy mask**.

## Streaming and storage

### How to choose video compression format

Deciding which compression method to choose depends on your viewing requirements, and on the properties of your network. The available options are:

#### Motion JPEG

Motion JPEG or MJPEG is a digital video sequence that is made up of a series of individual JPEG images. These images are then displayed and updated at a rate sufficient to create a stream that shows constantly updated motion. For the viewer to perceive motion video the rate must be at least 16 image frames per second. Full motion video is perceived at 30 (NTSC) or 25 (PAL) frames per second.

The Motion JPEG stream uses considerable amounts of bandwidth, but provides excellent image quality and access to every image contained in the stream.

#### H.264 or MPEG-4 Part 10/AVC

##### Note

H.264 is a licensed technology. The Axis product includes one H.264 viewing client license. Installing additional unlicensed copies of the client is prohibited. To purchase additional licenses, contact your Axis reseller.

H.264 can, without compromising image quality, reduce the size of a digital video file by more than 80% compared to the Motion JPEG format and by as much as 50% compared to the MPEG-4 standard. This means that less network bandwidth and storage space are required for a video file. Or seen another way, higher video quality can be achieved for a given bitrate.

Find out more at [axis.com/compression-formats](http://axis.com/compression-formats)

### How to reduce bandwidth and storage

##### Important

If you reduce the bandwidth it can result in less details in the picture.

1. Go to live view and select H.264.
2. Go to the **Stream** tab.
3. Do one or more of the following:
  - Turn on the Zipstream functionality and select the desired level.
  - Turn on dynamic GOP and set a high GOP length value.
  - Increase the compression.
  - Turn on dynamic FPS.

### How to add audio to your recording

Edit the stream profile which is used for the recording:

1. Go to **Settings > System > Stream profiles**.
2. Select the stream profile to modify.
3. In the **Audio** tab, select the **Audio stream** checkbox and select **On** from the drop-down list.



# AXIS P5635-E Mk II PTZ Dome Network Camera

## Setup

---

4. Click Ok.

## Overlays

### About overlays

Overlays are superimposed over the video stream. They are used to provide extra information during recordings, such as a timestamp, or during product installation and configuration.

### How to display the pan or tilt position as a text overlay

It may be useful to retrieve, for instance from a recorded video, the pan or tilt position in degrees in which an event has taken place. This can be obtained by including the position in the image as a text overlay, using a so-called modifier.

1. Go to **Settings > Overlay**.
2. In the text field, enter #*x* to show the pan position.  
Enter #*y* to show the tilt position.
3. Choose alignment, text size and appearance.
4. Include the text overlay.
5. The current pan and tilt positions show up in the live view image and in the recording.

## PTZ (Pan Tilt Zoom)

### How to limit pan, tilt, and zoom movements

In this example, the camera is surveilling a parking lot with nearby apartment buildings. Set pan, tilt and zoom limits to ensure privacy for residents.

To limit pan and tilt:

1. Go to **Settings > PTZ > Advanced > Limits**.
2. Set limits for pan and tilt.
3. Click **Save**.

To limit zoom:

1. Go to **Settings > PTZ > Basic**.
2. Set **Zoom tele limit**.

### About guard tours

A guard tour displays the video stream from different preset positions either in a predetermined or random order, and for configurable periods of time. Once started, a guard tour continues to run until stopped, even when there are no clients (web browsers) viewing the images.

How to create a guard tour with preset positions

1. Go to **Settings > PTZ > Guard tours**
2. Click **+**.
3. Select **Preset position**.

# AXIS P5635-E Mk II PTZ Dome Network Camera

## Setup

---



4. To edit the guard tour's properties, click
5. Type a name for the guard tour and specify the pause length in minutes between each tour.
6. If you want the guard tour to go to the preset positions in a random order, turn on **Shuffle**.
7. Click **Done**.
8. Click **Add** to add the preset positions that you want in your guard tour.
9. Click **Done** to exit the guard tour settings.
10. To schedule the guard tour, go to **System > Events**.

## Events

### About events

The event pages allow you to configure your product to perform actions when different events occur. For example, the product can start a recording or send an email notification when motion is detected. The set of conditions that defines how and when the action is triggered is called an action rule.

### How to direct the camera to a preset position when the camera detects motion

This example explains how to set up the camera to go to a preset position when it detects motion in the image.

Make sure the AXIS Video Motion Detection application is running:

1. Go to **Settings > Apps > AXIS Video Motion Detection**.
2. Start the application if it is not already running.
3. Make sure you have set up the application according to your needs.

Add a preset position:

4. Go to **Settings > PTZ** and set where you want the camera to be directed by creating a preset position.

Create an action rule:

5. Go to **Settings > System > Events > Action rules** and add an action rule.
6. Type a name for the action rule.
7. From the list of triggers, select **Applications** and then select **AXIS Video Motion Detection (VMD)**.
8. From the list of actions, select **PTZ Control** and then select **Preset Position**.
9. Select the preset position you want the camera to go to.
10. Click **Ok**.

### How to direct the camera and open the lock to a gate when someone is nearby

This example explains how to direct the camera and open a gate when someone wants to enter during daytime. This is done by connecting a PIR sensor to the product's input port and a switch relay to the product's output port via the multicable.

#### Required hardware

- Multicable (sold separately), see *AXIS Multicable C I/O Audio Power*.

# AXIS P5635-E Mk II PTZ Dome Network Camera

## Setup

- Mounted PIR sensor
- Switch relay connected to the gate lock, in this case the switch is normally closed (NC)
- Connecting wires

### Physical connection

1. Remove the plug from the camera's multi-connector and connect the multicable.
2. Connect the wires from the PIR sensor to the input pin, see *AXIS Multicable C I/O Audio Power*.
3. Connect the wires from the switch to the output pin, see *AXIS Multicable C I/O Audio Power*.

### Configure I/O ports

You need to connect the switch relay to the camera in the camera's webpage. First, configure the I/O ports:

#### Set the PIR sensor to an input port

1. Go to **System > I/O ports**.

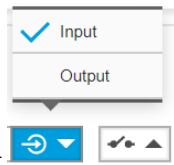

2. Select **Input** in the **Port 1** drop-down list.
3. Give the output module a descriptive name, for example "PIR sensor".
4. To trigger an event whenever the PIR sensor detects something, select **Open circuit** in the drop-down

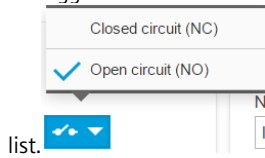

#### Set the switch relay to an output port

1. Go to **System > I/O ports**.

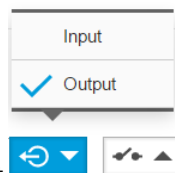

2. Select **Output** in the **Port 2** drop-down list.
3. Give the output module a descriptive name, for example "Gate switch".

4. To open the gate whenever an event is triggered, select **Closed circuit** in the drop-down list.

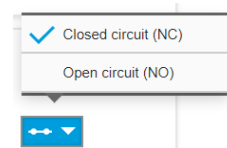

#### Create the preset position

1. Go to **Settings > PTZ > Preset positions**.

# AXIS P5635-E Mk II PTZ Dome Network Camera

## Setup

---

2. Create the preset position that covers the entrance of the gate and name it, for example, "Gate entrance".

### Create action rules

For the camera to open the gate when the PIR sensor detects someone nearby, you need to create an action rule in the camera:

1. Go to **System > Events > Action rules**.
2. Click **Add**.
3. Give the action rule a name, for example "Open gate".
4. From the **Trigger** drop-down list, select **Input signal**.
5. Select **Digital input signal**.
6. Select "PIR sensor", in this example connected to port 1.
7. Under **Actions**, select **Output port** from the **Type** drop-down list.
8. From the **Port** drop-down list, select "Gate switch" .
9. Click **Ok**.
10. Create another action rule with the name "Direct the camera to the gate"
11. Select the same input signal as before, but as action select the previously created "Gate entrance" preset position.
12. Click **Ok**.

### How to record video when the camera detects loud noises

This example explains how to set up the camera to start recording to the SD card five seconds before it detects loud noise and to stop one minute after.

Make sure audio turned on:

1. Set up the stream profile to include audio, see *How to add audio to your recording*.

Make sure the audio detection is set up:

2. Go to **Settings > System > Detectors > Audio detection**.
3. Adjust the alarm level according to your needs.

Create an action rule:

4. Go to **Settings > System > Events** and add an action rule.
5. Type a name for the action rule.
6. From the list of triggers, select **Detectors** and then select **Audio Detection**.
7. From the list of actions, select **Record video** and then select **Preset Position**.
8. Select the stream profile where audio has been turned on or create a new one.
9. Set the pre-trigger time to 5 seconds.
10. Set the post-trigger time to 60 seconds.
11. Select **SD card** from the list of storage options.
12. Click **Ok**.

# AXIS P5635-E Mk II PTZ Dome Network Camera

## Setup

---

### How to automatically zoom in on a specific area with gatekeeper

This example explains how to use the gatekeeper functionality to make the camera zoom in automatically on the license plate of a car that passes through a gate. When the car has passed, the camera zooms out to the home position.

Create the preset positions:

1. Go to **Settings > PTZ > Preset positions**.
2. Create the home position that includes the entrance of the gate.
3. Create the zoomed-in preset position so that it covers the area in the image where you assume that the license plate will appear.

Create a motion detection profile:

4. Go to **Settings > Apps** and open **AXIS Video Motion Detection**.
5. Create a profile that covers the entrance of the gate and then save the profile.

Create an action rule:

6. Go to **Settings > System > Events** and add an action rule.
7. Name the action rule *Gatekeeper*.
8. From the trigger list, select **Applications** and then select the previously created motion detection profile.
9. From the action list, select the previously created preset position.
10. Click **OK**.

### How to record video when the camera detects impact

Shock detection allows the camera to detect tampering caused by vibration or shock. Vibration caused by the environment or an object can trigger an action depending on the shock sensitivity range, which can be set from 0 to 100. In this scenario, someone is throwing rocks at the camera during after hours and you would like to receive a video clip of the event.

1. Go to **Settings > System > Detectors**.
2. Enable shock detection and set shock sensitivity value.
3. Click **Save**.

Create an action rule:

4. Go to **Settings > System > Events** and add an action rule.
5. Type a name for the action rule.
6. From the list of triggers, select **Detectors** and then select **Shock detection**.
7. From the list of schedules, select **After Hours**.
8. From the list of actions, select **Send Video Clip**.
9. Select an existing stream profile or create a new one.
10. Set the pre-trigger time to 5 seconds.
11. Set the post-trigger time to 60 seconds.
12. Select an existing recipient or create a new one.
13. Click **Ok**.

# AXIS P5635-E Mk II PTZ Dome Network Camera

## Setup

---

### Applications

#### About applications

AXIS Camera Application Platform (ACAP) is an open platform that enables third parties to develop analytics and other applications for Axis products. To find out more about available applications, downloads, trials and licenses, go to [axis.com/applications](https://axis.com/applications)

To find the user manuals for Axis applications, go to [axis.com](https://axis.com)

#### Note

- Several applications can run at the same time but some applications might not be compatible with each other. Certain combinations of applications might require too much processing power or memory resources when run in parallel. Verify that the applications work together before deployment.

# AXIS P5635-E Mk II PTZ Dome Network Camera

## Troubleshooting

---

### Troubleshooting

#### How to reset to factory default settings

##### Important

Reset to factory default should be used with caution. A reset to factory default resets all settings, including the IP address, to the factory default values.

To reset the product to the factory default settings:

1. Press and hold the control button and the power button for 15–30 seconds until the status LED indicator flashes amber. See *Product overview*.
2. Release the control button but continue to hold down the power button until the status LED indicator turns green.
3. Release the power button and assemble the product.
4. The process is now complete. The product has been reset to the factory default settings. If no DHCP server is available on the network, the default IP address is 192.168.0.90
5. Using the installation and management software tools to assign an IP address, set the password and access the video stream.

#### How to check the current firmware

Firmware is the software that determines the functionality of network devices. One of your first actions when troubleshooting a problem should be to check the current firmware version. The latest version may contain a correction that fixes your particular problem.

To check the current firmware:

1. Go to the product's webpage.
2. Click on the help menu. 
3. Click **About**.

#### How to upgrade the firmware

##### Important

Preconfigured and customized settings are saved when the firmware is upgraded (provided that the features are available in the new firmware) although this is not guaranteed by Axis Communications AB.

##### Note

When you upgrade the product with the latest firmware, the product receives the latest functionality available. Always read the upgrade instructions and release notes available with each new release before upgrading the firmware. To find the latest firmware and the release notes, go to [axis.com/support/firmware](https://axis.com/support/firmware)

1. Download the latest firmware file to your computer, available free of charge at [axis.com/support/firmware](https://axis.com/support/firmware)
2. Log in to the product as an administrator.
3. Go to **Settings > System > Maintenance** in the product's webpage and follow the instructions.
4. The upgrade takes a while, don't break the power to the product. When the upgrade is finished, the product restarts automatically.

# AXIS P5635-E Mk II PTZ Dome Network Camera

## Troubleshooting

---

AXIS Camera Management can be used for multiple upgrades. Find out more at [axis.com/products/axis-camera-management](http://axis.com/products/axis-camera-management)

### Technical issues, clues and solutions

If you can't find what you're looking for here, try the troubleshooting section at [axis.com/support](http://axis.com/support)

---

#### Problems upgrading the firmware

Firmware upgrade failure	If the firmware upgrade fails, the product reloads the previous firmware. The most common reason is that the wrong firmware file has been uploaded. Check that the name of the firmware file corresponds to your product and try again.
--------------------------	---

---

#### Problems setting the IP address

The product is located on a different subnet	If the IP address intended for the product and the IP address of the computer used to access the product are located on different subnets, you cannot set the IP address. Contact your network administrator to obtain an IP address.
--	---

The IP address is being used by another device	Disconnect the Axis product from the network. Run the ping command (in a Command/DOS window, type <code>ping</code> and the IP address of the product): <ul style="list-style-type: none"><li>• If you receive: <code>Reply from &lt;IP address&gt;: bytes=32; time=10...</code> this means that the IP address may already be in use by another device on the network. Obtain a new IP address from the network administrator and reinstall the product.</li><li>• If you receive: <code>Request timed out</code>, this means that the IP address is available for use with the Axis product. Check all cabling and reinstall the product.</li></ul>
--	---

Possible IP address conflict with another device on the same subnet	The static IP address in the Axis product is used before the DHCP server sets a dynamic address. This means that if the same default static IP address is also used by another device, there may be problems accessing the product.
---	---

---

#### The product cannot be accessed from a browser

Cannot log in	When HTTPS is enabled, ensure that the correct protocol (HTTP or HTTPS) is used when attempting to log in. You may need to manually type <code>http</code> or <code>https</code> in the browser's address field.
---------------	--

If the password for the user `root` is lost, the product must be reset to the factory default settings. See *How to reset to factory default settings*.

The IP address has been changed by DHCP	IP addresses obtained from a DHCP server are dynamic and may change. If the IP address has been changed, use AXIS IP Utility or AXIS Camera Management to locate the product on the network. Identify the product using its model or serial number, or by the DNS name (if the name has been configured).
---	---

If required, a static IP address can be assigned manually. For instructions, go to [axis.com/support](http://axis.com/support).

Certificate error when using IEEE 802.1X	For authentication to work properly, the date and time settings in the Axis product must be synchronized with an NTP server. Go to <b>Settings &gt; System &gt; Date and time</b>
--	---

---

#### The product is accessible locally but not externally

Router configuration	Check that your router allows incoming data traffic to the Axis product. The router must support UPnP®.
----------------------	---

Firewall protection	Check the Internet firewall with your network administrator.
---------------------	--

---

#### Problems with streaming

Multicast H.264 only accessible by local clients	Check if your router supports multicasting, or if the router settings between the client and the product need to be configured. The TTL (Time To Live) value may need to be increased.
--	--



# AXIS P5635-E Mk II PTZ Dome Network Camera

## Troubleshooting

---

No multicast H.264 displayed in the client	<p>Check with your network administrator that the multicast addresses used by the Axis product are valid for your network.</p> <p>Check with your network administrator to see if there is a firewall preventing viewing.</p>
Poor rendering of H.264 images	<p>Ensure that your graphics card is using the latest driver. The latest drivers can usually be downloaded from the manufacturer's website.</p>
Color saturation is different in H.264 and Motion JPEG	<p>Modify the settings for your graphics adapter. Go to the adapter's documentation for more information.</p>
Lower frame rate than expected	<ul style="list-style-type: none"><li>• See <i>Performance considerations on page 17</i>.</li><li>• Reduce the number of applications running on the client computer.</li><li>• Limit the number of simultaneous viewers.</li><li>• Check with the network administrator that there is enough bandwidth available.</li><li>• Lower the image resolution.</li><li>• In the product's webpage, set a capture mode that prioritizes frame rate. Changing the capture mode to prioritize frame rate might lower the maximum resolution depending on the product used and capture modes available.</li></ul>

### Performance considerations

When setting up your system, it is important to consider how various settings and situations affect the performance. Some factors affect the amount of bandwidth (the bitrate) required, others can affect the frame rate, and some affect both. If the load on the CPU reaches its maximum, this also affects the frame rate.

The following factors are the most important to consider:

- High image resolution or lower compression levels result in images containing more data which in turn affects the bandwidth.
- Access by large numbers of Motion JPEG or unicast H.264 clients affects the bandwidth.
- Simultaneous viewing of different streams (resolution, compression) by different clients affects both frame rate and bandwidth.

Use identical streams wherever possible to maintain a high frame rate. Stream profiles can be used to ensure that streams are identical.

- Accessing Motion JPEG and H.264 video streams simultaneously affects both frame rate and bandwidth.
- Heavy usage of event settings affects the product's CPU load which in turn affects the frame rate.
- Using HTTPS may reduce frame rate, in particular if streaming Motion JPEG.
- Heavy network utilization due to poor infrastructure affects the bandwidth.
- Viewing on poorly performing client computers lowers perceived performance and affects frame rate.
- Running multiple AXIS Camera Application Platform (ACAP) applications simultaneously may affect the frame rate and the general performance.

# AXIS P5635-E Mk II PTZ Dome Network Camera

## Specifications

---

### Specifications

To find the latest version of the product's datasheet, go to [axis.com](http://axis.com) > [product] > Support & Documentation.

### LED indicators

Status LED	Indication
Unlit	Connection and normal operation.
Green	Shows steady green for 10 seconds for normal operation after startup completed.
Amber	Steady during startup. Flashes during firmware upgrade or reset to factory default.
Amber/Red	Flashes amber/red if network connection is unavailable or lost.

### SD card slot

#### **NOTICE**

- Risk of damage to SD card. Do not use sharp tools, metal objects, or excessive force when inserting or removing the SD card. Use your fingers to insert and remove the card.
- Risk of data loss and corrupted recordings. Do not remove the SD card while the product is running. Unmount the SD card from the product's webpage before removal.

This product supports SD/SDHC/SDXC cards (not included).

For SD card recommendations, see [axis.com](http://axis.com)

### Buttons

#### Control button

The control button is used for:

- Resetting the product to factory default settings. See *How to reset to factory default settings on page 15*.
- Connecting to an AXIS Video Hosting System service. To connect, press and hold the button for about 3 seconds until the status LED flashes green.

#### Power button

Press and hold the power button to temporarily power the product when the dome cover is removed. The power button is also used with the control button to reset the camera to factory default settings. See *page 15*.

### Connectors

#### Network connector

RJ45 Ethernet connector with Power over Ethernet Plus (PoE+).

# AXIS P5635-E Mk II PTZ Dome Network Camera

## Specifications

### NOTICE

### AXIS Multicable C I/O Audio Power

When connecting external equipment to the product, a separately sold AXIS Multicable C I/O Audio Power 1 m/ 5 m is required in order to maintain the product's IP rating.

Connect the multicable to the product's multi-connector. To locate the multi-connector, see *Product overview*.

The multicable provides the following connectors:

**Power connector** – 2-pin terminal block used for AC or DC power input. Use a Safety Extra Low Voltage (SELV) compliant limited power source (LPS) with either a rated output power limited to  $\leq 100$  W or a rated output current limited to  $\leq 5$  A. Ground for AC/DC.

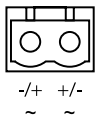

Function	Pin	Notes	Specifications
AC/DC Power input	Polarity independent	Use a Safety Extra Low Voltage (SELV) compliant limited power source (LPS) with either a rated output power limited to $\leq 100$ W or a rated output current limited to $\leq 5$ A. Ground for AC/DC	24 V AC/DC

**Audio connector** – 4-pin terminal block used for audio in and audio line out. This can be connected to a public address (PA) system or an active speaker with a built-in amplifier.

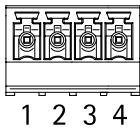

Function	Pin	Notes
Audio In	1	Balanced or unbalanced input for a mono microphone or line signal
Audio Line Out	3	Can be connected to a public address (PA) system or an active speaker with a built-in amplifier
GND	2, 4	Ground

**I/O connector** – 6-pin terminal block. Use with external devices in combination with, for example, tampering alarms, motion detection, event triggering, time lapse recording and alarm notifications. In addition to the 0 V DC reference point and power (DC output), the I/O connector provides the interface to:

- Digital output – For connecting external devices such as relays and LEDs. Connected devices can be activated by the VAPIX® Application Programming Interface, output buttons on the Live View page or by an Action Rule. The output will show as active (shown under **System Options > Port & Devices > Port Status**) if the alarm device is activated.
- Digital input – An alarm input for connecting devices that can toggle between an open and closed circuit, for example: PIRs, door/window contacts, glass break detectors, etc. When a signal is received the state changes and the input becomes active (shown under **System Options > Port & Devices > Port Status**).

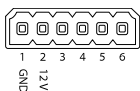

# AXIS P5635-E Mk II PTZ Dome Network Camera

## Specifications

Function	Pin	Notes	Specifications
DC Output	2	Can be used to power auxiliary equipment. Note: This pin can only be used as power out.	12 V DC Max load = 50 mA
GND	1	Ground	
Configurable (Input or Output)	3 - I/O 1 4 - I/O 2 5 - I/O 3 6 - I/O 4	Digital input – Connect to pin 8 to activate, or leave floating (unconnected) to deactivate.	0 to max 30 V DC
		Digital output – Connected to pin 8 when activated, floating (unconnected) when deactivated. If used with an inductive load, e.g. a relay, a diode must be connected in parallel with the load, for protection against voltage transients.	0 to max 30 V DC, open drain, 100 mA

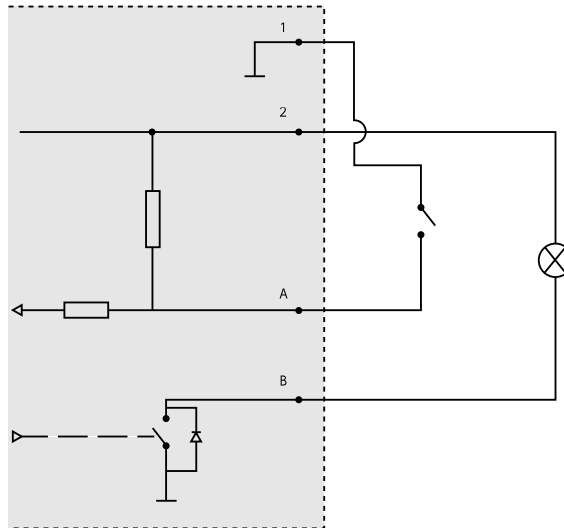

- 1 GND
- 2 DC output 12 V, max 50 mA
- A I/O configured as input
- B I/O configured as output

### Axis 10-pin push-pull system connector (sold separately)

When connecting external equipment to the Axis product, an Axis 10-pin Push-Pull System Connector (sold separately) is required in order to maintain the product's IP rating.

Mounting the wires requires a crimp tool. To get detailed mounting instructions of the wires, go to [axis.com/support](http://axis.com/support)

Connect the 10-pin push-pull system connector to the product's multi-connector. To locate the multi-connector go to .

#### 10-pin push-pull system connector

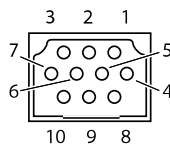
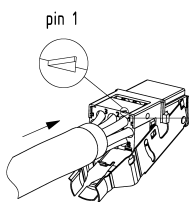

# AXIS P5635-E Mk II PTZ Dome Network Camera

## Specifications

---

Function	Pin	Notes	Specifications
AC/DC Power input	9, 10	The input is polarity independent. Use a Safety Extra Low Voltage (SELV) compliant limited power source (LPS) with either a rated output power limited to $\leq 100$ W or a rated output current limited to $\leq 5$ A.	24 V AC/DC
Configurable (Input or Output)	3 – I/O 1 5 – I/O 2 6 – I/O 3 7 – I/O 4	Digital input – Connect to pin 8 to activate, or leave floating (unconnected) to deactivate.	0 to max 30 V DC
		Digital output – Connected to pin 8 when activated, floating (unconnected) when deactivated. If used with an inductive load, e.g. a relay, a diode must be connected in parallel with the load, for protection against voltage transients.	0 to max 30 V DC, open drain, 100 mA
DC Output	2	Can be used to power auxiliary equipment. Note: This pin can only be used as power out.	12 V DC Max load = 50 mA
GND	8	Ground for audio and I/O	
Audio Line Out	4	Can be connected to a public address (PA) system or an active speaker with a built-in amplifier	
Audio In	1	Balanced or unbalanced input for a mono microphone or line signal	

